



2SD669/A

NPN SILICON TRANSISTOR

BIPOLAR POWER GENERAL PURPOSE TRANSISTOR

APPLICATIONS

* Low frequency power amplifier complementary pair with UTC 2SB649/A

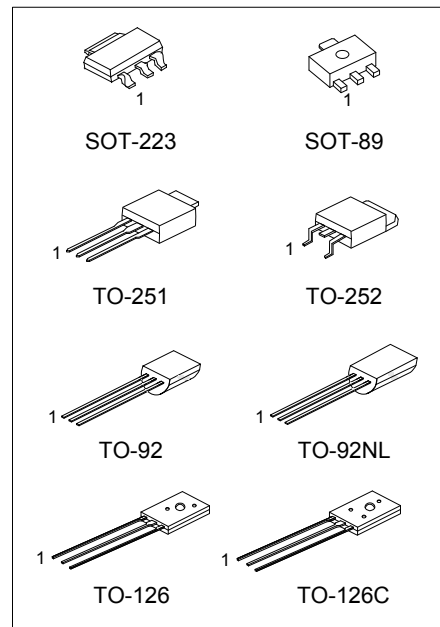

Lead-free: 2SD669L/2SD669AL
Halogen-free: 2SD669G/2SD669AG

ORDERING INFORMATION

Ordering Number			Package	Pin Assignment			Packing
Normal	Lead Free	Halogen Free		1	2	3	
2SD669x-x-AA3-R	2SD669xL-x-AA3-R	2SD669xG-x-AA3-R	SOT-223	B	C	E	Tape Reel
2SD669x-x-AB3-R	2SD669xL-x-AB3-R	2SD669xG-x-AB3-R	SOT-89	B	C	E	Tape Reel
2SD669x-x-T60-K	2SD669xL-x-T60-K	2SD669xG-x-T60-K	TO-126	E	C	B	Bulk
2SD669x-x-T6C-K	2SD669xL-x-T6C-K	2SD669xG-x-T6C-K	TO-126C	E	C	B	Bulk
2SD669x-x-T92-B	2SD669xL-x-T92-B	2SD669xG-x-T92-B	TO-92	E	C	B	Tape Box
2SD669x-x-T92-K	2SD669xL-x-T92-K	2SD669xG-x-T92-K	TO-92	E	C	B	Bulk
2SD669x-x-T9N-B	2SD669xL-x-T9N-B	2SD669xG-x-T9N-B	TO-92NL	E	C	B	Tape Box
2SD669x-x-T9N-K	2SD669xL-x-T9N-K	2SD669xG-x-T9N-K	TO-92NL	E	C	B	Bulk
2SD669x-x-TM3-T	2SD669xL-x-TM3-T	2SD669xG-x-TM3-T	TO-251	B	C	E	Tube
2SD669x-x-TN3-R	2SD669xL-x-TN3-R	2SD669xG-x-TN3-R	TO-252	B	C	E	Tape Reel

<p>2SD669xL-x-AB3-R</p> <p>(1)Packing Type (2)Package Type (3)Rank (4)Lead Plating (5) Collector-Emitter Voltage</p>	<p>(1) B: Tape Box, K: Bulk, R: Tape Reel (2) AA3: SOT-223, AB3: SOT-89, T60: TO-126, T6C: TO-126C, TM3: TO-251, TN3: TO-252, T92:TO-92, T9N: TO-92NL (3) x: refer to Classification of h_{FE1} (4) G: Halogen Free, L: Lead Free, Blank: Pb/Sn (5) A: 160V, Blank: 120V</p>
--	---

■ ABSOLUTE MAXIMUM RATING (Ta=25°C unless otherwise specified)

PARAMETER		SYMBOL	RATINGS	UNIT
Collector-Base Voltage		V_{CB0}	180	V
Collector-Emitter Voltage	2SD669	V_{CE0}	120	V
	2SD669A		160	
Emitter-Base Voltage		V_{EBO}	5	V
Collector Current		I_C	1.5	A
Collector Peak Current		$I_{C(PEAK)}$	3	A
Collector Dissipation	SOT-223	P_D	0.5	W
	SOT-89		0.5	W
	TO-126/TO-126C		1	W
	TO-92/TO-92NL		0.6	W
	TO-251		1	W
	TO-252		2	W
Junction Temperature		T_J	150	°C
Storage Temperature		T_{STG}	-40 ~ +150	°C

Note: Absolute maximum ratings are those values beyond which the device could be permanently damaged.

Absolute maximum ratings are stress ratings only and functional device operation is not implied.

■ ELECTRICAL CHARACTERISTICS (Ta=25°C, unless otherwise specified)

PARAMETER	SYMBOL	TEST CONDITIONS	MIN	TYP	MAX	UNIT
Collector to Base Breakdown Voltage	BV_{CB0}	$I_C=1mA, I_E=0$	180			V
Collector to Emitter Breakdown Voltage	BV_{CE0}	$I_C=10mA, R_{BE}=\infty$	120			V
			160			
Emitter to Base Breakdown Voltage	BV_{EBO}	$I_E=1mA, I_C=0$	5			V
Collector Cut-off Current	I_{CBO}	$V_{CB}=160V, I_E=0$			10	μA
DC Current Gain	h_{FE1}	$V_{CE}=5V, I_C=150mA$ (Note)	60		320	
	h_{FE2}	$V_{CE}=5V, I_C=500mA$ (Note)	30			
Collector-Emitter Saturation Voltage	$V_{CE(SAT)}$	$I_C=600mA, I_B=50mA$ (Note)			1	V
Base-Emitter Voltage	V_{BE}	$V_{CE}=5V, I_C=150mA$ (Note)			1.5	V
Current Gain Bandwidth Product	f_T	$V_{CE}=5V, I_C=150mA$ (Note)		140		MHz
Output Capacitance	C_{ob}	$V_{CB}=10V, I_E=0, f=1MHz$		14		pF

Note: Pulse test.

■ CLASSIFICATION OF h_{FE1}

RANK	B	C	D
RANGE	60-120	100-200	160-320

TYPICAL CHARACTERISTICS

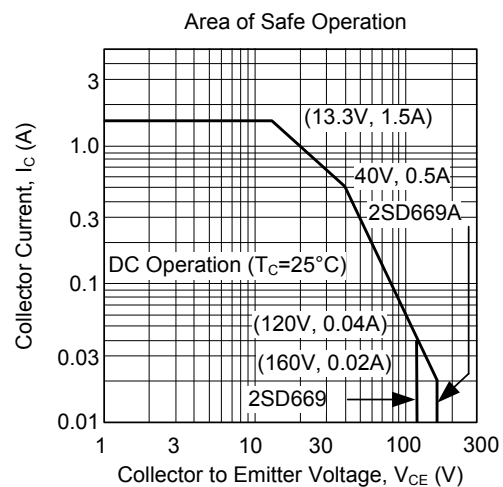
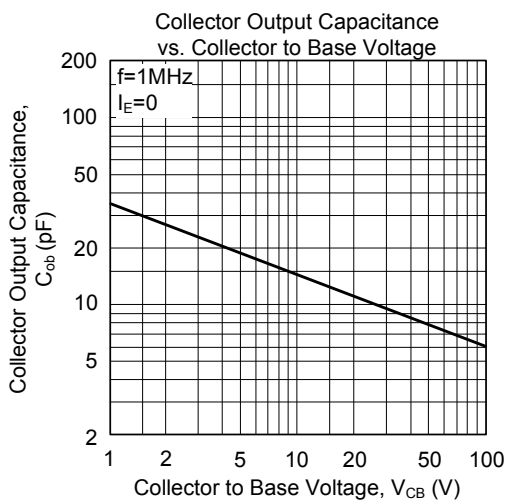
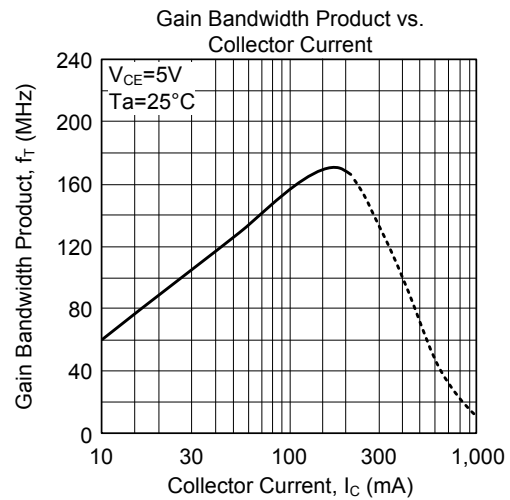
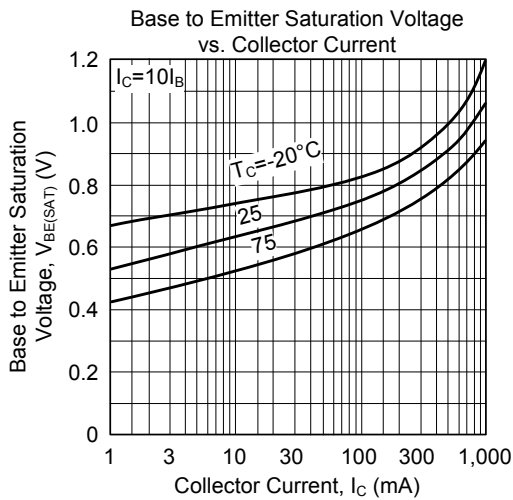
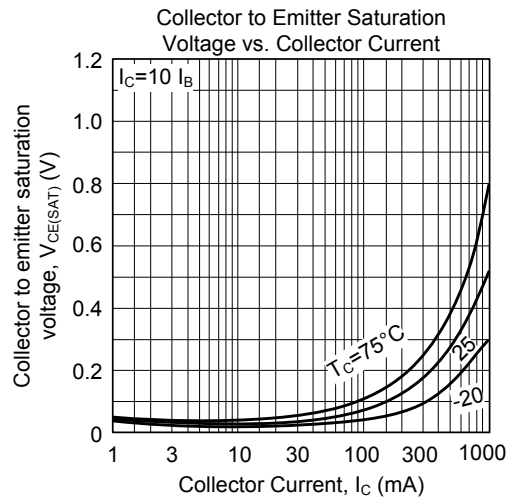
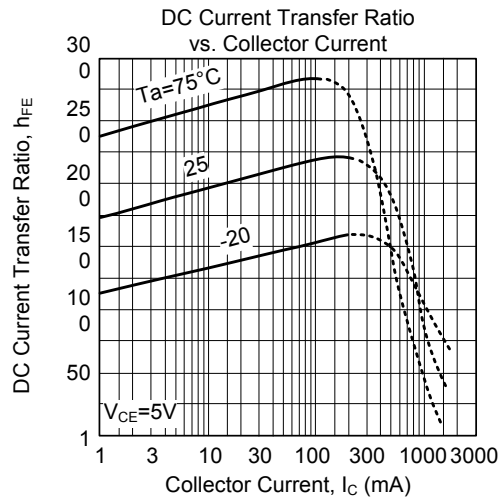

■ TYPICAL CHARACTERISTICS(Cont.)

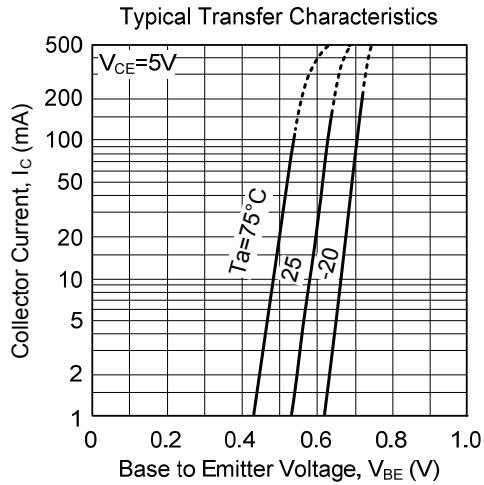

UTC assumes no responsibility for equipment failures that result from using products at values that exceed, even momentarily, rated values (such as maximum ratings, operating condition ranges, or other parameters) listed in products specifications of any and all UTC products described or contained herein. UTC products are not designed for use in life support appliances, devices or systems where malfunction of these products can be reasonably expected to result in personal injury. Reproduction in whole or in part is prohibited without the prior written consent of the copyright owner. The information presented in this document does not form part of any quotation or contract, is believed to be accurate and reliable and may be changed without notice.